



SB-V01

Rail Mount Timing Equipment
for Industrial Applications

Rev 1.0

Dichiarazione di conformità Declaration of conformity	
La Ditta <i>The Company</i>	DIGITAL INSTRUMENTS S.r.l. Via Parco degli Scout, 13 20091 BRESSO (MI) ITALY
Dichiaro con la presente che il Prodotto <i>Herewith declares that the Product</i>	
Tipo / <i>Type</i>	Rail Mount Timing Equipment for Industrial Applications
Modello / <i>Model</i>	SB-V01
Serial Number	0230 /
Oggetto di questa dichiarazione è conforme ai seguenti standard o norme della Comunità Europea <i>Referred to by this declaration is in conformity with the following standards or normative documents of EC</i>	
Norme Europee Armonizzate <i>European Armonized Standards</i>	
CEI EN 61000-6-4:2007	Electromagnetic compatibility (EMC) - Part 6-4: Generic standards - Emission standard for industrial environments
CEI EN 61000-6-2:2006	Electromagnetic compatibility (EMC) - Part 6-2: Generic standards - Immunity for industrial environments
CEI EN 55011:2011	Limits and methods of measurement of radio disturbance characteristics of industrial, scientific and medical (ISM) radio-frequency equipment
CEI EN 61000-4-2:2011	Electromagnetic compatibility (EMC) - Part 4-2: Testing and measurement techniques - Electrostatic discharge immunity test
CEI EN 61000-4-3:2007+A1:2009+A2:2011	Electromagnetic compatibility (EMC) - Part 4-3: Testing and measurement techniques - Radiated, radio-frequency, electromagnetic field immunity test
CEI EN 61000-4-4:2006+A1:2010	Electromagnetic compatibility (EMC) - Part 4-4: Testing and measurement techniques - Electrical fast transient/burst immunity test
CEI EN 61000-4-5:2007	Electromagnetic compatibility (EMC) - Part 4-5: Testing and measurement techniques - Surge immunity test
CEI EN 61000-4-6:2011	Electromagnetic compatibility (EMC) - Part 4-6: Testing and measurement techniques - Immunity to conducted disturbances, induced by radio-frequency fields
CEI EN 61000-4-8:1997+A1:2001	Electromagnetic compatibility (EMC) - Part 4-8: Testing and measurement techniques - Power frequency magnetic field immunity test
CEI EN 61000-4-11:2010	Electromagnetic compatibility (EMC) - Part 4-11: Testing and measurement techniques - Voltage dips, short interruptions and voltage variations immunity tests
CEI EN 60204-1:2006+A1:2010	Safety of machinery - Electrical equipment of machines - Part 1: General requirements
Bresso, July 2014	DIGITAL INSTRUMENTS S.r.l. Via Parco degli Scout, 13 20091 BRESSO (MI) ITALY <i>Marco Genova</i> <i>Quality Assurance Manager</i>

Istruzioni di sicurezza Safety Instructions

Il dispositivo è stato progettato, costruito e collaudato in conformità alle normative richiamate nel Certificato di Conformità ed è stato rilasciato dal costruttore completamente testato secondo gli standard di sicurezza. Per mantenere questa condizione e assicurare la sicurezza d'uso, l'utente deve osservare tutte le istruzioni e segnalazioni di pericolo descritte in questo manuale.

This unit has been designed and tested in accordance with the EC Certificate of Conformity and has left the manufacturer's plant in a condition fully complying with safety standard. To maintain this condition and to ensure safe operation, the user must observe all the instructions and warnings given in this operating manual.

- **Prima di mettere in servizio il dispositivo, leggere attentamente ed integralmente le istruzioni per l'uso. Osservarle e seguirle in tutti i punti. Provvedere in modo che le istruzioni per l'uso siano sempre accessibili a tutti gli addetti.**

Prior to switching on the unit, please read carefully the instructions on the manual. Keep this manual available for all every user of this equipment.

- **Il terminale PE sul dispositivo deve essere connesso al conduttore PE prima di eseguire qualsiasi altra connessione. L'installazione ed il cablaggio devono essere eseguiti da personale tecnico qualificato.**

The PE terminal of the unit must first be connected to the PE conductor on site before any other connections are made. Installation and cabling of the unit to be performed only by qualified technical personnel.

- **Lo strumento supporta alimentazione AC wide range da 95 Vac a 240 Vac e deve essere connesso tramite protezione con corrente nominale massima pari a 16A.**

This unit may be operate from wide range AC supply networks from 95 Vac to 240 Vac fused with max. 16A.

- **Lo strumento supporta alimentazione DC wide range da 20 Vdc a 50 Vdc e deve essere connesso tramite protezione con corrente nominale massima pari a 5A. Il circuito di protezione contro l'inversione di polarità è implementato a bordo.**

This unit may be operate from wide range DC supply networks from 20 Vdc to 50Vdc fused with max. 5A. Circuit against polarity inversion is also implemented.

Le condizioni di sicurezza vanno testate ad ogni sostituzione. Ispezione visiva dei cavi, stato dell'isolamento, corrente di dispersione, stato del connettore PE e test funzionale.

A safety test must be performed after each replacement of part. Visual inspections, PE conductor test, insulation resistance, leakage-current measurement, functional test.

- **Non interrompere il conduttore PE in nessun caso. Un'interruzione del cavo PE rende l'apparato elettricamente pericoloso.**

It is not permissible to interrupt PE conductor intentionally, neither in the incoming cable nor on the unit itself as this may cause the unit become electrically hazardous.

- **Ogni riparazione, manutenzione e sostituzione del dispositivo deve essere eseguita unicamente da personale autorizzato dalla Digital Instruments.**

Any adjustments, replacements of parts, maintenance or repair may be carried out only by authorized Digital Instruments technical personnel.





- **Assicurarsi che ogni collegamento con dispositivi informatici sia eseguito secondo IEC950/EN60950**

Ensure that the connections with information technology equipment comply with IEC950/EN60950

Simboli di sicurezza Safety Symbols

Sono presenti sul dispositivo e nella documentazione simboli utilizzati per la segnalazione di segnalazione conformi alle specifiche IEC61010-1 II.

Safety-related symbols used on equipment and documentation comply with IEC 61010-1 II.

	<ul style="list-style-type: none"> • SIMBOLO DIRECT CURRENT IEC 417, N°5031 Vdc may be used on rating labels
	<ul style="list-style-type: none"> • SIMBOLO ALTERNATING CURRENT IEC 417, N°5032 For rating labels, the symbol is typically replaced by V and Hz as in 230V, 50Hz.
	<ul style="list-style-type: none"> • SIMBOLO PROTECTIVE CONDUCTOR TERMINAL IEC 417, N°5019 This symbol is specifically reserved for the PROTECTIVE CONDUCTOR TERMINAL and no other. It is placed at the equipment earthing point and is mandatory for all grounded equipment
	<ul style="list-style-type: none"> • SIMBOLO CAUTION ISO 3864, N°B.3.1 used to direct the user to the instruction manual where it is necessary to follow certain specified instructions where safety is involved.

Changelog

Rev.	Note	Data
1.0	First revision	02/07/2014

SB-V01

Rail Mount Timing Equipment for Industrial Applications

Index

Summary	6
Front View	7
Connectors details	8
Main Operation	9
GPS	9
E1	10
NTP	11
PTP (IEEE 1588)	12
IRIG-B	13
Date and time	15
Switchover Function	15
Switch Policies	15
Switchover Treshold	15
WEB Interface	18
Event Log	25
SNMP Trap Management	26
User Account	26
Custom Settings	27
First Run	28
Appendix A: Quality Factor	29
General Review	29
GPS antenna positioning	29
Quality Factor	30
Statistics	31
Automatic Site Survey	31
Technical Data	33

Summary

This manual provides to the user of the apparatus **SB-V01** all the information necessary for proper operation. The informations include the normal installation procedures and any data on the maintenance and programming in order to facilitate interventions in the field.

SB-V01 is compact rail mount timing equipment able to reconstruct stable IRIG-B references from various sources (GPS, IRIG-B AM, IRIG-B DCLS, PTP, E1).

SB-V01 is a very flexible solution suited to all those applications where is necessari to provide a stable time-frequency reference to multiple devices. whilst mantaining electrical isolation.

When an error on the selected source is observed an error condition is generated via SNMP and dry contacts and a new source is selected between the available ones as per user configured priority.

SB-V01 is quite simple to use and to set-up. Every function can be accessed remotely via WEB or SNMP.

SB-V01 gives informations about its internal status via 7dry contacts placed on the rear panel and the LEDs on the front panel.

SB-V01 has double Power Supply Unit, to ensure best safety and uninterrupted work.

SB-V01 is in metallic box of sizes (H/W/D) 112.3 x 71.7 x 160.0 mm for rail mounting.



Additional configurations may be used with the SB-V01 device.
Please consult Digital Instruments to discuss further customizations.

Note

This document may contain confidential and or reserved material of property of Digital Instruments S.r.l. It cannot be reproduced, used or shown to third parties for any other scope than the intended one.



WARNING: Before inserting the power supply please carefully read all instructions for proper installation.

Front View

The front panel appears as shown in the following figure.

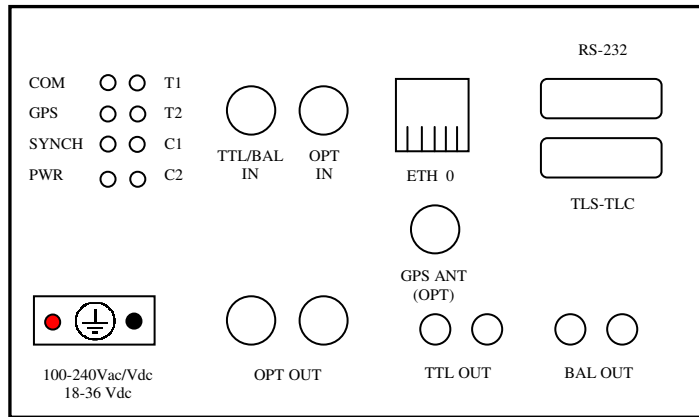

The SB-V01 does not provide any supply switch.

Connectors details

RS-232

The DB9 DCE connector requires a crossover cable to communicate with a standard PC.

In order to connect the PC to the device and execute a firmware upgrade via serial line a female-female null-modem serial cable is required:

RS232 NULL MODEM CABLE

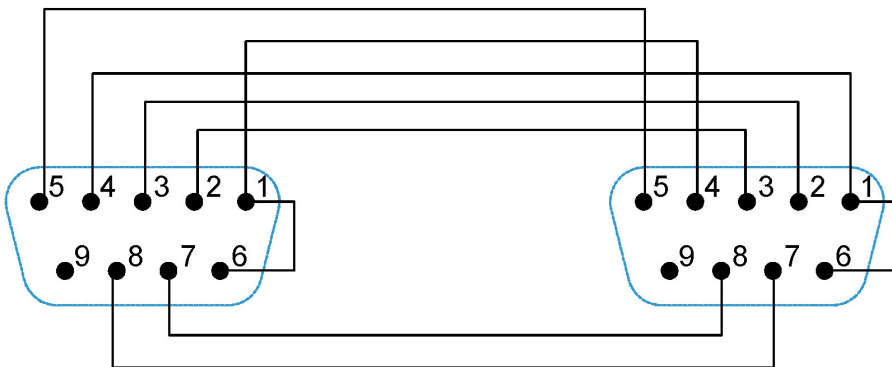

In particular the following lines have to be swapped (as shown above):

- 2 and 3 (TX– RX)
- 4 and 6 (DTR – DSR)
- 7 and 8 (RTS – CTS)

TLS - TLC connector

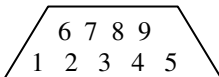

The 9 poles DB9 connector used for:

- PIN 1: Closed contact → T1 Reference valid
- PIN 6: Closed contact → T2 Synchronization completed
- PIN 2: Common contact → T1 / T2
- PIN 7: No Connect
- PIN 3: GND contact → C1
- PIN 8: VCC contact → C1
- PIN 4: GND contact → C2
- PIN 9: VCC contact → C2
- PIN 5: Ground

Main Operation

The main purpose of the **SB-V01** is to provide stable output signals of Time (PPS, E1, IRIG code, NTP/PTP) and Frequency (10 MHz, 2.048MHz), and to enable the synchronization of the network.

This is allowed by the application of algorithms, tuning an high-stability internal oscillator.

Peculiarities of the **SB-V01** is the possibility to accept input from four different sources:

1. GPS (Optional)
2. E1 (Optional)
3. PTP (IEEE 1588)
4. IRIG-B

In this manner it is possible to switch from one source to another, if a fault occurs.

The strong difference between the various sources is a major strength as it makes the same apparatus both very flexible to suit the needs of the customer and very strong in order to better cope with possible failures of a type of source (for example, the loss of accuracy of the GPS signal).

Even in case of a switch, references of Time / Frequency provided are kept stables.

GPS

The apparatus is internally equipped with a GPS receiver especially suitable for use as a time reference. The GPS receiver is able to reproduce the local PPS signal relative to UTC second with a precision of typically ± 100 ns. With this feature is possible to regulate the internal oscillator apparatus for producing a high-stability output signals.



This feature is provided as an option and may not be available in the default configuration.

E1

The E1 signal, standardized by the European Conference of Postal and Telecommunications Administrations (CEPT) and subsequently adopted by the International Telecommunication Union Telecommunication Standardization Sector (ITU-T), operates at a nominal value of 2.048 Mbps and is widely used in digital telecommunications worldwide, with the exception of USA and Canada (where the T1 signal is in use) and Japan (where is in use the J1). The E1 link operates on two separate coaxial cables (Rx and Tx).



This feature is provided as an option and may not be available in the default configuration.

Also in this case it's possible perform a rapid frequency locking with the 2.048 MHz reference of E1 signal, setting the *Disciplining Mode* voice to the *frequency* value.

Status Informations

SB-V01 allows to view the status of the E1 module through the following values:

- Presence or absence of E1 signal
- Presence or absence of E1 framing
- SSM Quality (Rec. ITU-T G.704, see below) of the synchronization source
- Bit Error Rate is calculated by the BERT (see below)
- BERT Irq Array, binary array of interrupt requests that triggered errors generated in BERT (see below)
- Delay between the E1 PPS and the PPS generated by OCXO

Available Settings

SB-V01 allows the possibility to set the device as a supplier of synchronization signal E1 (E1 Master), in case where it's connected to valid synchronization sources (GPS, cesium oscillator, etc.), or as a sevice receiver of E1 synchronization signal (E1 Slave). In the first case, it is also possible to choose the quality of the source, according to the table of Recommendation G.704 (ITU-T):

Quality Level	Value Displayed	Description of Sync Quality Level
0	Unknown	Quality Unknown (existing synchronization network)
1	Reserved	
2	G.811	Recommendation G.811
3	Reserved	
4	SSU-A	Synchronization Supply Unit A (Note 1)
5	Reserved	
6	Reserved	
7	Reserved	
8	SSU- B	Synchronization Supply Unit B (Note 1)
9	Reserved	
10	Reserved	
11	SETS	Synchronous Equipment Timing Source (SETS)
12	Reserved	
13	Reserved	
14	Reserved	
15	DON'T USE	Do not use for synchronization
Note 1: In previous versions was used the terms "G.812 transit" and "G.812 local", for more information, see Rec G.812 (ITU-T)		

SB-V01 allows to choose on which of the 30 (from 2 to 32, excluding 17) timeslots of the E1 frame transmit the PPS signal. As default, the signal is sent and received on timeslot 32. The timeslots 1 and 17 are used to send sync and control data by E1. The PPS is implemented by putting up only the LSB of the selected timeslot.

SB-V01 allows to test the quality of the physical channel on which the E1 signal is transmitted activating the Bit Error Rate Test (in reception and / or transmission), and choosing which of timeslots (except for the one used for the PPS and, advising against the first, where the sync data are sent) to receive and / or send the signal for the test. The form of the Bit Error Rate Test can generate and detect pattern both pseudo-random and repetitive. It's used to test and stress the channels of communication data. Has been set the pseudo random pattern QRSS for testing. The apparatus allows to show the value of the bit error rate and the log of interrupts that have generated errors in the BERT, the latter is defined thus: 0X1X2X3X4X5X60 where:

- X1 passes from 0 to 1 occurs when the reception of an error;
- X2 passes from 0 to 1 when an overflow occurs in the counter total BERT;
- X3 goes from 0 to 1 when an overflow occurs on the BERT error counter;
- X4 changes from 0 to 1 when received 32 '1' row;
- X5 goes from 0 to 1 when received 32 '0' row;
- X6 from 0 to 1 when there is loss of synchronization;

SB-V01 allows to choose which "column" (from 4 to 8) of bits use to transmit the value of the signal quality. By default this value is sent and received on the column 8.

NTP

The NTP (Network Time Protocol) is a well-established standard for synchronization of PCs and other devices on the Internet or an Intranet network.

The accuracy of the order of tens of milliseconds, can be considered adequate for most situations. Its flexibility and strength, thanks to the many servers widely available, making it a very smart choice for time synchronization.

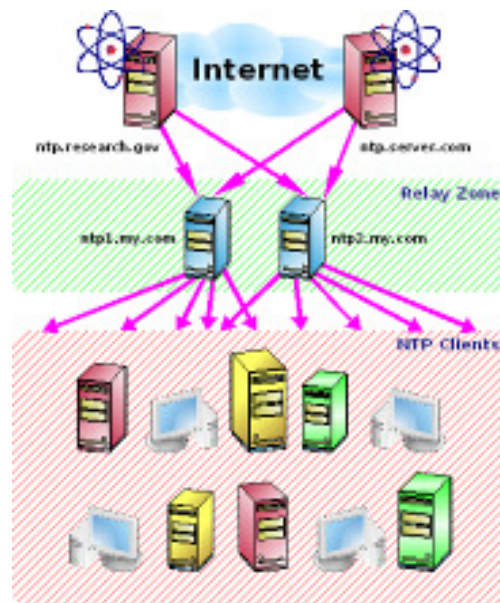

The device supports NTP server version 4 that distributes the synchronous time related to an external time reference (typically GPS, PTP or IRIG-B).

Currently is necessary to enable the PTP support in order to use its internal hardware counter even for NTP.

When the PTP protocol is not being used it can be set on SLAVE in order to free network resources.

PTP (IEEE 1588)

The **SB-V01** supports the IEEE 1588-2008 (version 2), also known as *Precision Time Protocol*, both as master and slave. When connected to an appropriate device compatible to the IEEE 1588 standard is able to synchronize the slave apparatus with a precision well below the micro-second.

Note that using network switches non-compliant with IEEE 1588, variable delays in the order of some tens of microseconds are introduced (as noted in the official website of the Protocol <http://ieee1588.nist.gov/switch.htm>).

The IEEE 1588 bases its operation on the calculation of the transit time of PTP packets from the master to the slave (and slave to master).

These latencies are calculated using a simple exchange of messages between master and slave that are associated with timestamps managed at the hardware level.

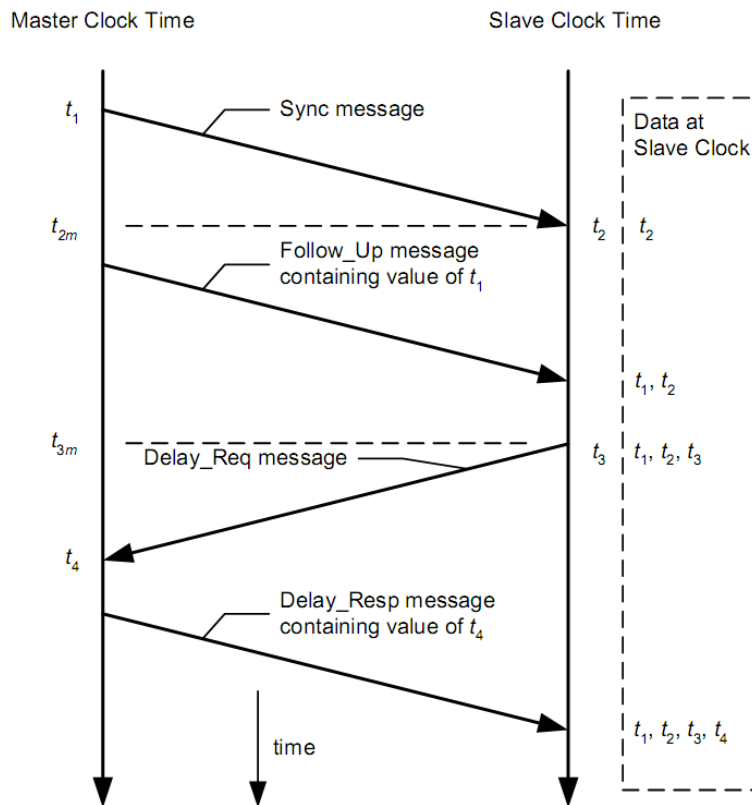

Once reconstructed the one-way-delay it is possible to use it to correct the clock of the slave and lock it to the master. Below is shown the pattern of the loop relative to the clock tuning based on PTP.

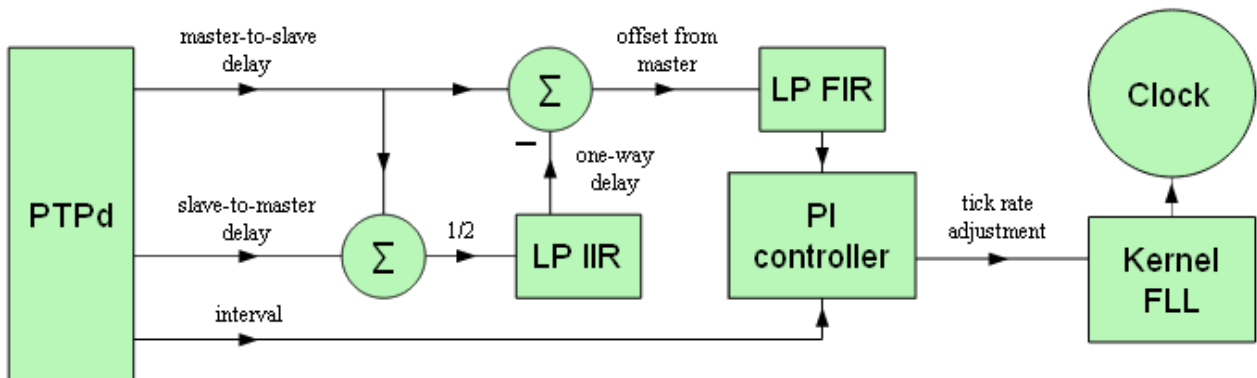

IRIG-B

The device can accept in input and provide in output (on BNC and optical connectors) an IRIG-B stream of type 006, compliant with following code:

Bit position	Information transmitted
0	Position identifier P_R (seconds' boundary marker)
1–4	Units of seconds
6–8	Tens of seconds
9	Position identifier P_1
10–13	Units of minutes
15–17	Tens of minutes
19	Position identifier P_2
20–23	Units of hours
25–26	Tens of hours
29	Position identifier P_3
30–33	Units of days
35–38	Tens of days
39	Position identifier P_4
40–41	Hundreds of days
49	Position identifier P_5
50–53	Units of year or control function bits
55–58	Tens of year or control function bits
59	Position identifier P_6
60–68	Control function bits
69	Position identifier P_7
70–78	Control function bits
79	Position identifier P_8
80–88	Nine lowest significant bits of time of day in straight binary seconds (bit 80 $\rightarrow 2^0$... bit 88 $\rightarrow 2^8$)
89	Position Identifier P_9
90–97	Eight most significant bits of time of day in straight binary seconds (bit 90 $\rightarrow 2^9$... bit 97 $\rightarrow 2^{16}$)
99	Position identifier P_0
Note: Bits not listed are index markers, and are sent as binary zeroes.	

It was also implemented part of the standard 1344-1995. The offset compared to the UTC time can be set using the Timezone of the apparatus. Changes of DST or leap second are not currently notified (always returned as 0).

IRIG-B Pos ID	CTRLB IT#	Designation	Explanation
P50	1	Year, BCD 1	Last 2 digits of year in BCD
P51	2	Year, BCD 2	IBID
P52	3	Year, BCD 4	IBID
P53	4	Year, BCD 8	IBID
P54	5	Not used	Unassigned
P55	6	Year, BCD 10	Last 2 digits of year in BCD
P56	7	Year, BCD 20	IBID
P57	8	Year, BCD 40	IBID
P58	9	Year, BCD 80	IBID
P59	-	P6	Position identifier # 6
P 60	10	Leap second pending (LSP)	Becomes 1 up to 59 s BEFORE leap second insert
P 61	11	Leap second (LS)	0 = Add leap second, 1 = Delete leap second
P62	12	Daylight saving pending (DSP)	Becomes 1 up to 59 s BEFORE DST change
P63	13	Daylight savings time (DST)	Becomes 1 during DST
P 64	14	Time offset sign	Time offset sign – 0=+, 1=-
P65	15	Time offset-binary 1	Offset from coded IRIG-B time to UTC time IRIG coded time plus time offset (including sign) equals UTC time at all times (offset will change during daylight savings)
P 66	16	Time offset-binary 2	
P 67	17	Time offset-binary 4	
P68	18	Time offset-binary 8	
P 69	-	P7	Position identifier # 7
P70	19	Time offset-0.5 hour	0 = none, 1 = additional 0.5 h time offset
P71	20	Time quality	4 b code representing approx. clock time error 0000 = clock locked, maximum accuracy 1111 = clock failed, data unreliable.
P72	21	Time quality	
P73	22	Time quality	
P74	23	Time quality	
P75	24	PARITY	Parity on all preceding data bits
P76	25	Not used	Unassigned
P77	26	Not used	Unassigned
P78	27	Not used	Unassigned
P79	-	P8	Position identifier # 8

The device can output an IRIG-B DCLS signal.
 It can also recognize an IRIG-B DCLS signal via a BNC connector.
 When the BNC connector is used it inhibits the external timing input.

Date and time

The device disciplines its internal clock from the selected reference (GPS, PTP, IRIG-B, NTP) and distributes it with the following rules:

- NTP (UTC timebase as per standard)
- PTP (TAI timebase as per standard)

Switchover Function

SB-V01 allows the possibility to switch the disciplining of its internal timebase selecting one of many sources. This exchange can be configured to run automatically upon occurrence of an alarm condition, such as:

- PPS signal absence
- disconnection of the antenna
- error in the E1 signal
- error in the PTP protocol
- error in the IRIG-B signal

In the log are reported the reason of the switch:

Mweb	→ user defined switch from WEB
Msnmp	→ user defined switch from SNMP
Mlcd	→ user defined switch from LCD
Mopto	→ user defined switch from TLC
Aser	→ automatic switch due to serial connection lack of GPS
Aant	→ automatic switch due to connection lack of GPS antenna
Apref	→ automatic switch to the higher priority source
Ae1	→ automatic switch caused by an error in the E1 signal
Aptp	→ automatic switch caused by errors in the PTP protocol
Airigb	→ automatic switch caused by an error in the IRIG-B signal

Switch Policies

The **SB-V01** permits to chose the priorità of the various sources.

Priorità is bigger when the value is bigger. 0 inhibits the source.

When the device is configured for automatic switchover two different policies can be used:

Switch & Free

The device switch to the best available source when an error is recognized on the actually selected source.

Switch & Pref

The device always switch to the source with highest priority currently available, if valid.

In order to avoid the possibility of continuos alarms due to intermittent switches there is a check that does not permit to switch more than 3 times in 5 minutes, by automatically lowering the policy (*Switch & Pref* → *Switch & Free*).

This event has been given the following code:

Event Code 007 Switch Alarm → Done more than 3 switches in less than 5 minutes

Switchover Treshold

This variable allows to define a time interval (in seconds) that must elapse between the time when an error has been identified and when it will be exchanged effectively. If during this time the error will disappear, the exchange will be deleted.

Characterization of Sources

SB-V01 was also designed to compare the quality of the different sources provided to apparatus, analyzing the ratio $\Delta f / f$ (variation of the frequency value on the nominal frequency) of each source. This analysis is supported by a graph (that can be generated by the *Stability Chart* button in the *Main Panel*) which shows the trend of these ratios over time.

The step used is 5 minutes, while the values are expressed in nanoseconds.

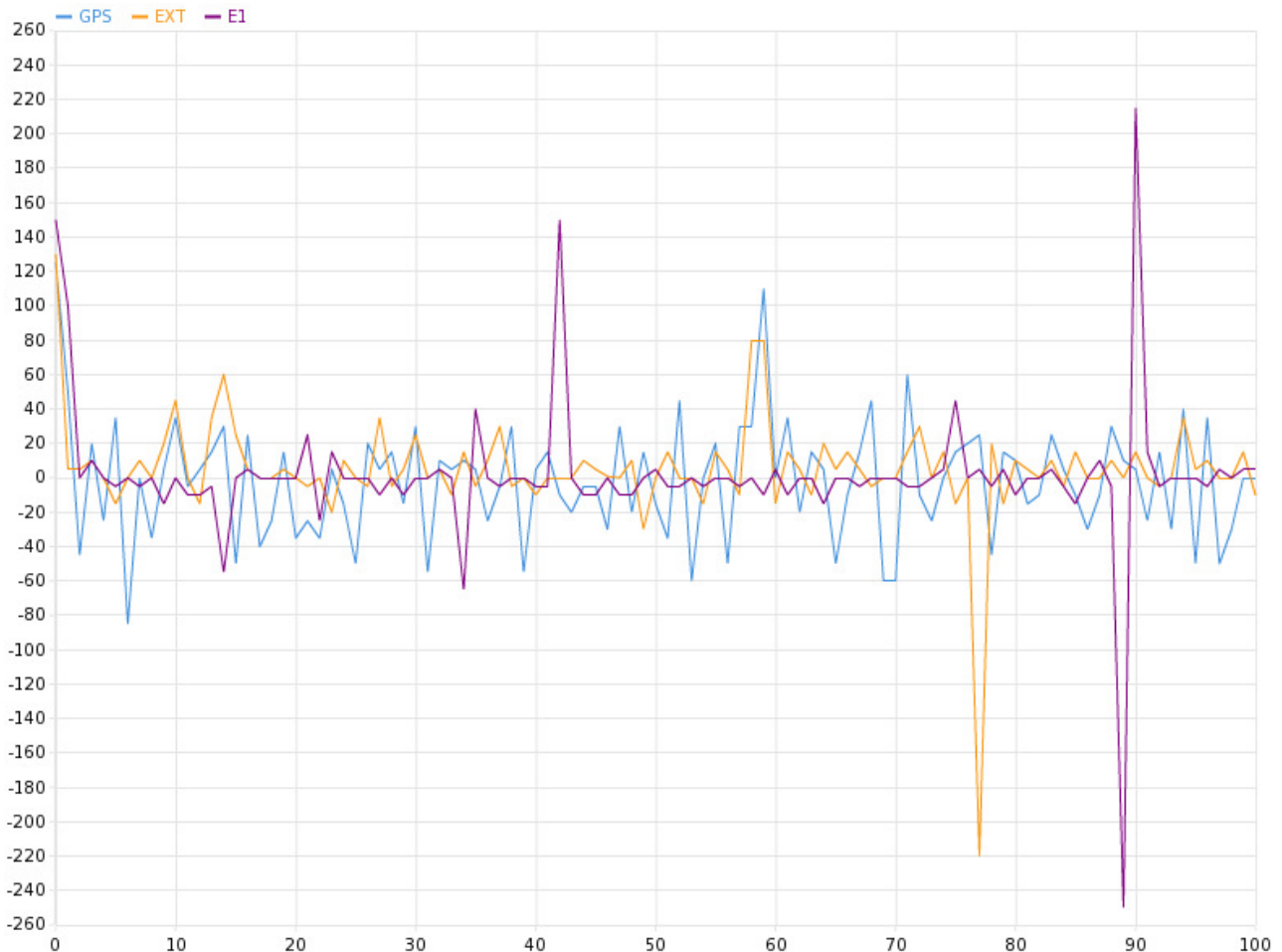

Moreover, is also possible display both on web interface (the *View* section of *Main Panel*), and on the LCD screen (below the status of each source), the delay, expressed in nanoseconds, between the PPS generated from the apparatus output and the three different tuning sources.

To correctly perform the characterization of various sources it's good configure the equipment with the following settings:

- Manual mode exchange
- GPS Source selected

It's good practice also expect that the PPS generated by the radio is valid and that its delay is close to 0 ns (visible from GPS → status).

It is also possible display the progress of these distances over time (using the button *Distance Chart* in the *Main Panel*).

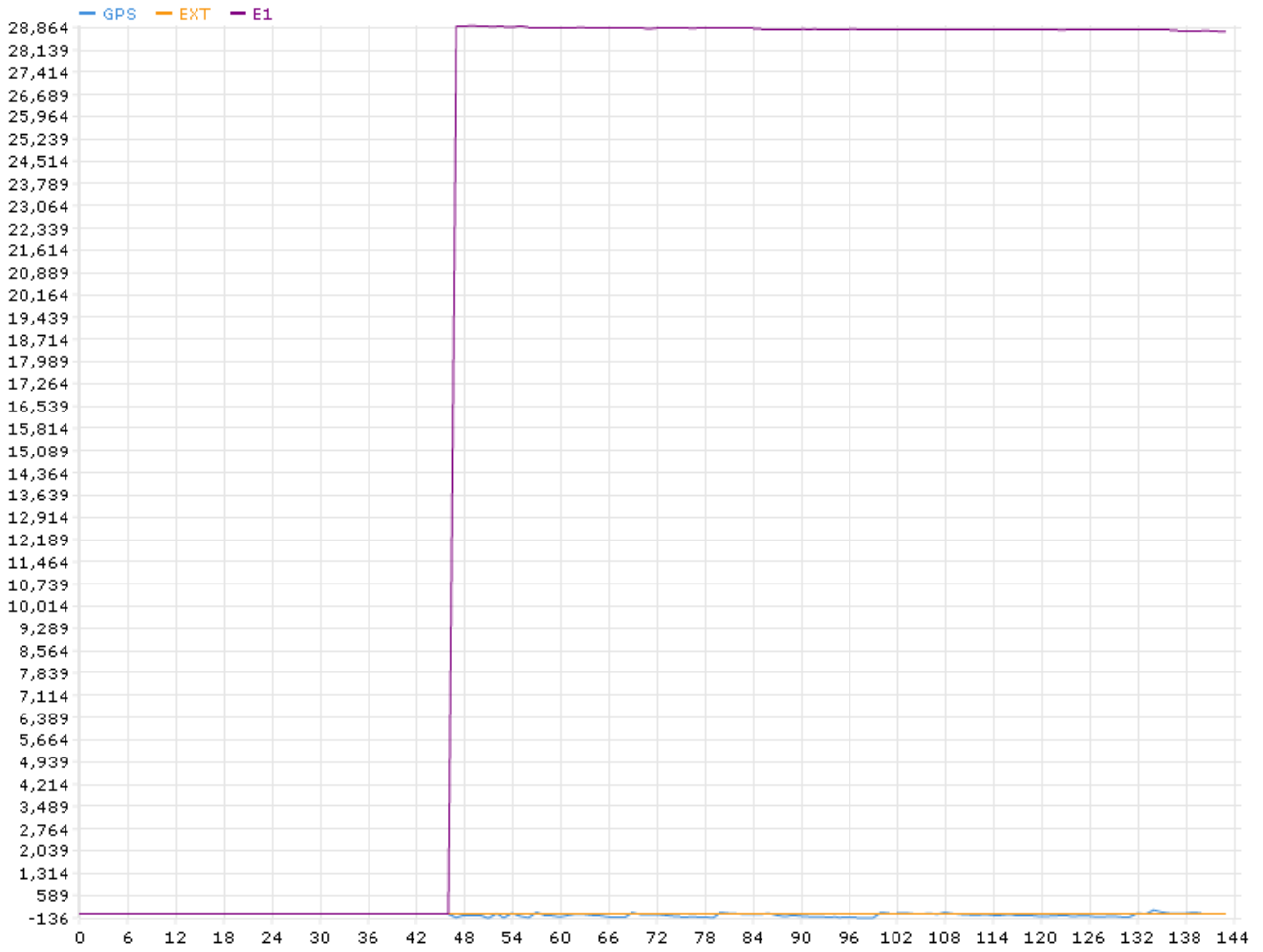

WEB Interface

The SB-V01 is managed by the network using a common browser by simply connecting to the associated IP address.

Network Configuration Panel

Board ID

Allows to define a name to the apparatus, useful for identifying it on the network

Trap Dest

Allows to configure the destination server of the traps related to the events.

IP

Allows to set up the IP address associated to the the specific network interface. To activate the changes, system needs to restart.

Netmask

Allows to set the netmask associated to specific network interface. To activate the changes, system needs to restart.

Gateway

Allows to set the gateway associated with specific network interface. To activate the changes, system needs to restart.

Reset to default

Restores the original configuration

Reboot the board

Restarts the device

Date & Time

Allows to view/set the date and time of the apparatus. Note that this will still be automatically updated to that received by satellite.

Timezone

Allows to set the UTC offset for proper time visualization.

This setting determines the IRIG-B time offset.

Guest Account Settings

Allows to change the credentials of the user account (see below for more details)

Admin Account Settings

Allows to change the credentials for the administrator account (see below for more details)

Board Config Panel

Source

Permits to force a switch on a different source when the device is configured in manual switch mode. To switch from the WEB interface just go the the *View* tab of the *Main Panel* and click on a source.

Manual/Auto

Allows to set the type of switching (manual or automatic).

Disciplining Mode

Selects the kind of tuning to use when discipling from da EXT or E1 reference. The frequency tune is faster, but loses the phase alignment of the PPS provided in output.

Policy

Indica la politica attualmente utilizzata per la commutazione in modalità automatica. Per avere maggiori

Indicates the policy used to do switchovers. To have more details on the subject please consult the relative section *Switchover Policies*.

Switchover

Allows to modify the switch-over time. For more details please consult the relative section *Switchover*.

Priority

Set the priority of each source for the automatic switch (a higher value means a higher priority, 0 disables the source).

PPS Mute

Inhibits the output of the PPS until the device has reached a synchronized status (typically a few minutes are needed).

PPS

Allows to choose which signal to spread on the PPS connectors (default is board PPS).

IRIG-B IN

Permits to choose the source of the IRIG-B input signal (BNC or OPTICAL)

IRIG-B OUT

Allows to choose which signal to spread on the IRIG-B BNC connectors (default is IRIG-B).

Positioning

Permits to change the position of the device (retrieved from GPS if available).

The screenshot shows a configuration interface with the following sections and values:

- Switch Mode:** Value: automatic
- Switch Policy:** Value: Switch and Pref
- Switchover:** Value: 0 sec
- Discipling Mode:** Value: Phase
- Holdover:** Value: 0 sec
- PPS Mute:** Value: On (radio button selected)
- Priority:**
 - IRIG-B: 5
 - PTP: 2
 - E1: 3
 - EXT: 4
 - GPS: 5
- Mux:**
 - PPS: PPS
 - IRIG-B IN: OPTICAL
 - IRIG-B OUT: IRIG-B
- Positioning:**
 - Latitude: 45.543930 °
 - Longitude: 9.195100 °
 - Altitude: 206.450000 m

Board Status

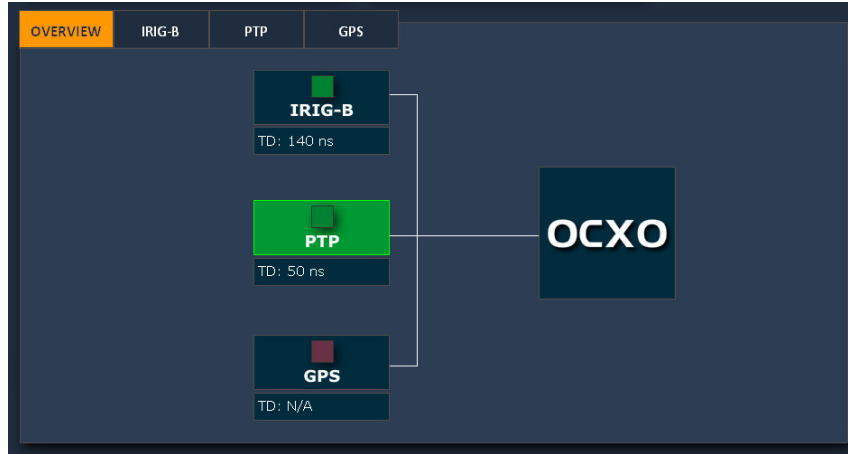

Overview

Permits to view the status of all the sources alongside their time reference comparison with the internal reference.

Info

Displays the name of the device and the corresponding software release. The ID field can be customized by the user to track the device.

These informations are displayed in the *Board Info* panel of the main page of the WEB interface.

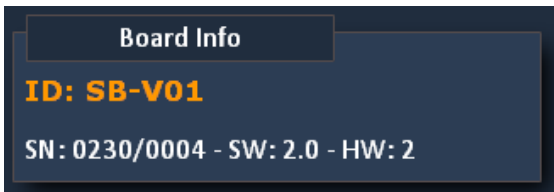

Board Status

Shows the current disciplining value given to the internal oscillator and the synchronization status.

These informations are reported in the *PPS Sync* and *Vtune* values on the *Main* panel.

TLC

Shows the status of the 2 TLC

- 0 → TLC inactive
- 1 → TLC active

TLS

Shows the status of the 2 TLS

- 0 → TLS inactive
- 1 → TLS active

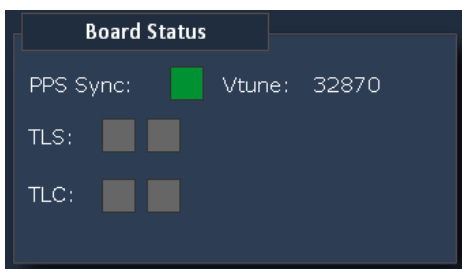

NTP

Displays some information about the NTP server.
 Sync: the led is green when the server is providing a correct date
 Stratum: 1 when locked to a primary source, 16 when unsynchronized
 Date: the date provided via NTP (please note that it always show the GMT time, despite of the timezone)

GPS

Status

Displays some information about the GPS radio.
 If present and its time delay in respect to the internal PPS.

Positioning Mode

Permits to set the way in which the GPS module should calculate its geographical position. If extract it from the information collected from the satellites or using the one given by the user.
 The “Altitude Hold” mode may not be available on every GPS module.

Latitude

Permits to view/set the latitude of the GPS antenna.

Longitude

Permits to view/set the longitude of the GPS antenna.

Height

Permits to view/set the height of the GPS antenna.

Cable Delay

Permits to set the length of the antenna cable connected to the GPS module, so to compensate the delays introduced by the signal propagation

Show Ch Status

Shows the status of the channels of the GPS receiver
 The snr, the elevation and the azimuth of the visible satellites are reported
 To cycle through the various channels use keys ↓ and ↑.

Show Global Info

Shows some info about the GPS module:
 Visible Sats → the number of visible satellites
 Tracked Sats → the number of tracked satellites
 PPS Status → the status of the PPS signal
 Antenna → the status of the antenna

All these variables are reported in the *GPS status* window. *Cable Delay* can be set in the *GPS Configuration*, whilst *Latitude*, *Longitude* and *Height* cannot be set by WEB, but only from SNMP or front panel.



The satellite view can be opened by pressing the *Polar view* button.

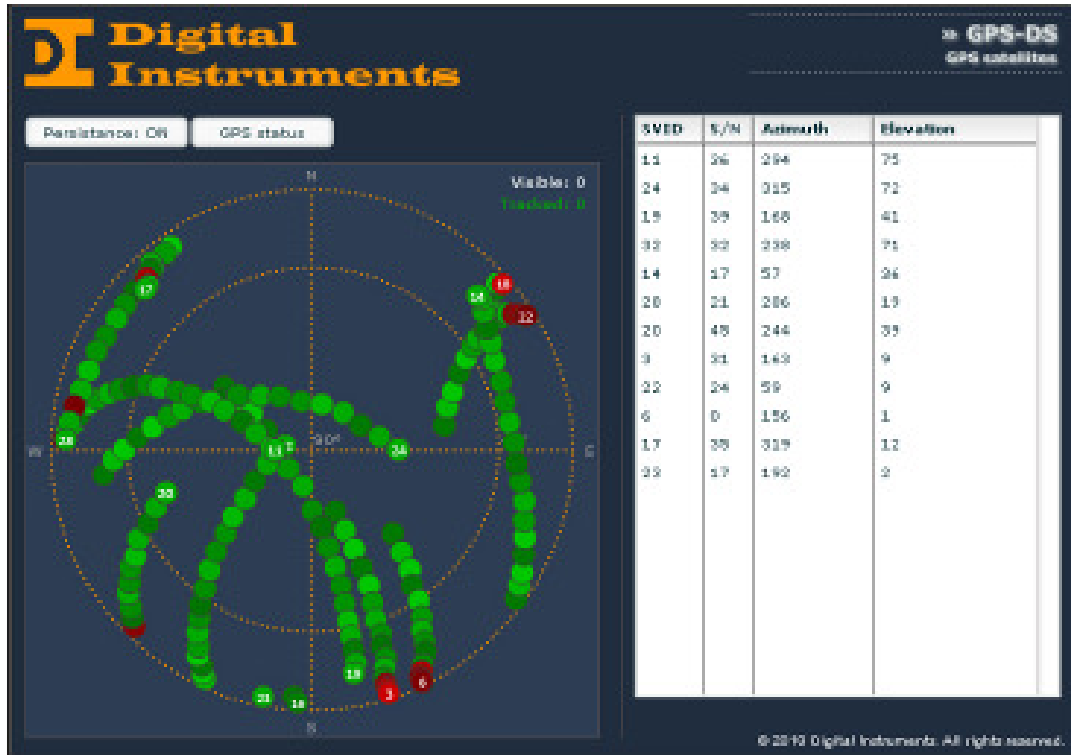

E1

For informations concerning the E1 status variables, see paragraph "E1" and specifically subsections "status information" and "settings available."

In the web interface it's possible view the values of state variables of the settings in Tab *E1* of the *Main Panel*, while is possible change the settings on the *E1 Config Panel*.



The screenshot displays a configuration interface with the following sections:

- PPS Timeslot:** Rx: 2, Tx: 2
- SSM Column:** Rx: 8, Tx: 8
- Master/Slave:** Set type: slave, Set SSM QL: (00) Unknown
- BERT Status:** Rx: [checkbox], Tx: [checkbox]
- Rx BERT Channels:** Grid of 32 channels (1-32) with channel 2 highlighted in yellow.
- Tx BERT Channels:** Grid of 32 channels (1-32) with channel 2 highlighted in yellow.
- PPS Offset:** Value: 0 ns
- PPS Insertion:** Value: 1

PTP

Enable

Allows to switch on or off the PTP.

Type

Allows to choose to configure the device as a Grandmaster or a Slave.

Profile

Allows to choose to choose between some predefined profiles for common configurations.

Multicast/Unicast

Allow to choose the type of communication mechanism.

IP Dest

Allows to define a series of additional unicast addresses.

Advanced

Allows to configure a set of advanced settings.

The PTP configuration panel includes the following settings:

- Source #1:** Multicast: [checked], Unicast: [unchecked]
- Enable:** [checked]
- Type:** slave
- Profile:** DEFAULT
- IP Dest 1:** 0.0.0.0
- IP Dest 2:** 0.0.0.0
- Advanced...:** [button]

Intervals

The various interval values are expressed in power of 2, so 0 corresponds to 1 second, 1 to 2 seconds and -1 to 0.5 seconds.

VLAN

Allow to enable or disable the 802.1Q protocol.

Follows a comparative table of the various profiles. In order to customize some specific values a CUSTOM profile must be chosen.

	DEFAULT	TELECOM	POWER
Sync	1/s	32/s	1/s
Announce	2s	8/s	1/s
Announce timeout	12s	0.25s	6s
Delay Request	8s	32/s	-
Peer Delay Request	-	-	1/s
Delay Mechanism	E2E	E2E	P2P
Domain Number	0	4	0
Encapsulation	UDP	UDP	Layer2
Routing	MULTICAST	UNICAST	MULTICAST

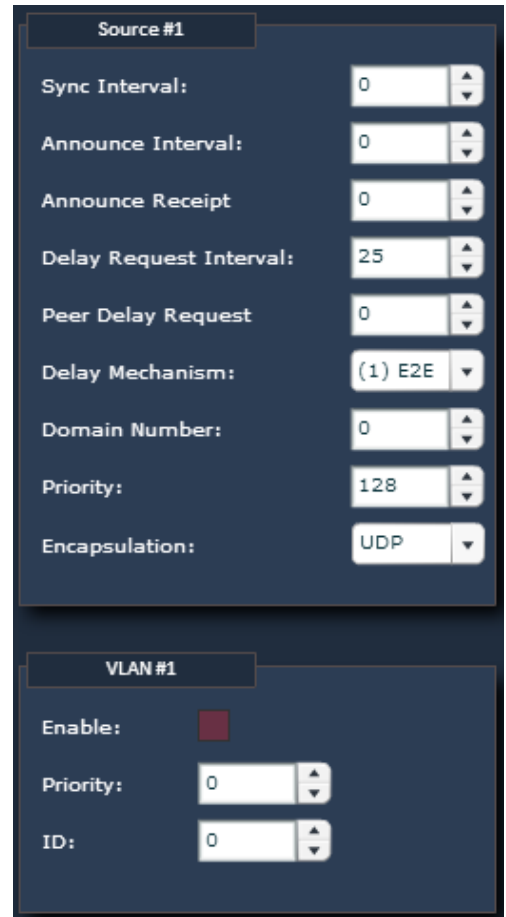

IRIG-B

It is possible to select what to output on the IRIG-B connector between:

- PPS
- IRIG-B
- CUSTOM PULSE #1
- CUSTOM PULSE #2
- CUSTOM CLOCK #1
- CUSTOM CLOCK #2

It is also possible to choose where to retrieve the IRIG-B signal from:

- AUTO
- OPTICAL
- ELECTRICAL (TTL IN)
- IRIG-B AM (BAL IN)

Furthermore is possible to choose if outputting an IRIG-B signal or IRIG-G.

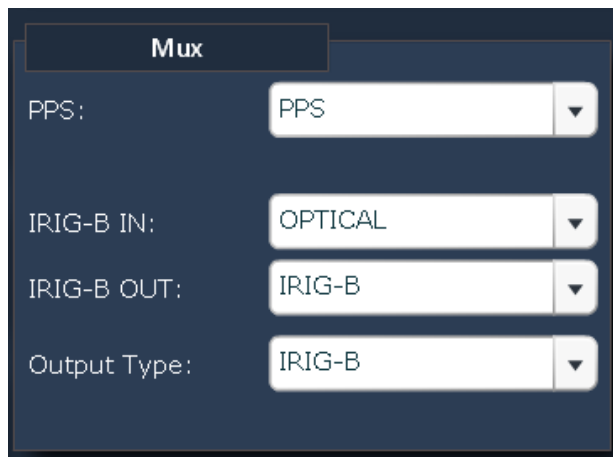

Event Log

On the WEB is available the apparatus log from *Event log* section.
 50 entries are presented.
 It is possible to delete the logs and save them in *csv*. format.

ID	Date	Time	Code	Description
1	09/12/09	10:41:59	003	PPS Al. 1
2	09/12/09	10:41:59	003	PPS Al. 2
3	09/12/09	10:41:59	003	PPS Al. 3
4	09/12/09	10:41:59	003	PPS Al. 4
5	09/12/09	10:41:59	003	PPS Al. 5
6	09/12/09	10:41:59	003	PPS Al. 6
7	09/12/09	10:50:51	011	PPS Syncr
8				
9				
10				
11				
12				
13				
14				
15				
16				
17				
18				
19				

Load data...
Save to CSV
Clear data

Events related to the board

- Event Code 001 Power ON → Apparatus on
- Event Code 002 Switch → Switching on GPS / EXT / E1 source
- Event Code 003 PPS alarm → Alarm on PPS (1÷4)
- Event Code 004 Clock alarm → Alarm on 10 MHz (1÷4) signal
- Event Code 005 GPS Serial → Detection or loss of connectivity of the GPS radio
- Event Code 006 Supply → Insertion or removal of a power supply (L, R)
- Event Code 007 Switch Alarm → More than 3 exchanges in less than 5 minutes
- Event Code 008 GPS PPS → Status change of PPS from satellite
- Event Code 009 GPS Antenna → GPS antenna connection or disconnection
- Event Code 010 Bad Vtune → Vtune incorrect value
- Event Code 011 PPS Syncr → Synchronization completed
- Event Code 012 E1 Signal → Change in the status of the presence of the E1 signal
- Event Code 013 E1 Frame → Change in the status of the presence of the E1 framing
- Event Code 014 E1 PPS → Change in the status of the presence of the E1 PPS
- Event Code 018 PTP PPS → Change in the status of the PPS rebuilt by PTP
- Event Code 019 IRIG-B → Change in the status of the presence of the IRIG-B signal

SNMP Trap Management

For each event related to the board, is generated a trap in parallel parallel to the machine set under TrapDest. The trap number reflects the event number and the contents of the SNMP variable associated contains the details (for example, the channel referred to the event).

User Account

The main user who has access to the apparatus is the administrator. He is able to change its credentials under *Account Settings*.

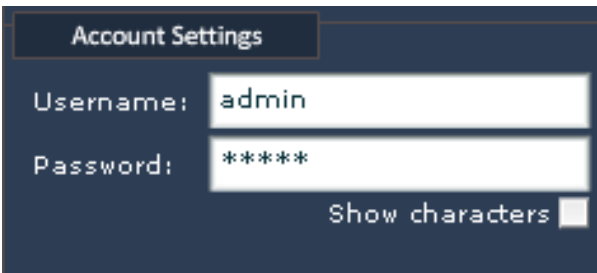

It's possible set a user account that is able to use the apparatus remotely in read-only mode, without the possibility of changing its configuration.

The username and password for this *guest* account can be set by the administrator under *Guest Account Settings*.

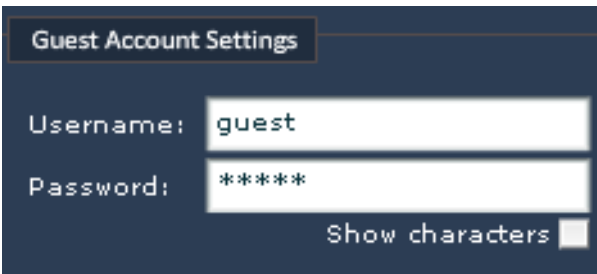

The default credentials are:

admin	→	admin / admin
guest	→	guest / guest

About SNMP:

Read community string	→	public
Write community string	→	public

Custom Settings

The device permits to have some ad-hoc customizations through the unlock with particular activation codes.

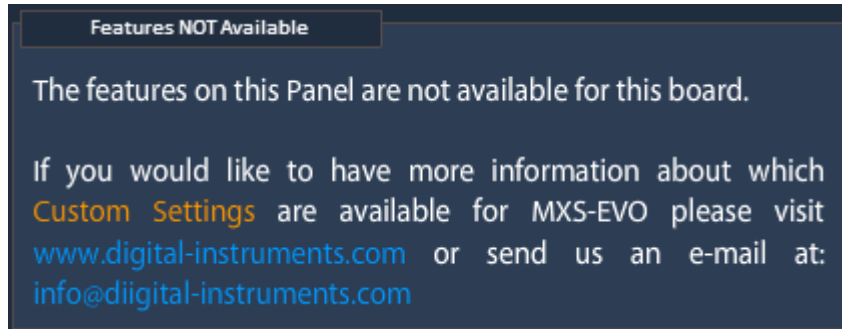

Pulse Generation

The device is able to generate a programmable pulse in place of the IRIG-B DCLS signal (on the BNC connector) or the PPS signal.

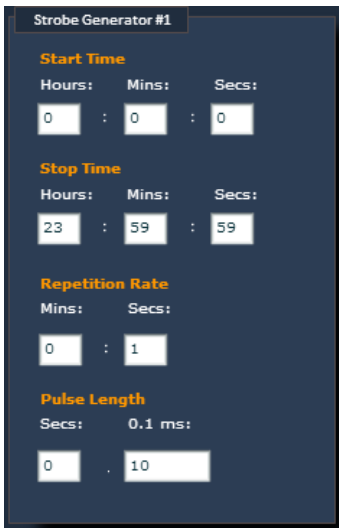

The following parameters can be set:

- <Start Time> HH:MM:SS
- <Stop Time> HH:MM:SS
- <Repetition Rate> MM:SS
- <Pulse Length> SS.ssss

The system generates a sequence of pulses of <Pulse Length> length and repeating every <Repetition Rate> starting at <Start Time> and stopping at <Stop Time>.

Please note that the <Start Time> is always synchronous to the internal PPS (eventually disciplined via an external source).

Clock Generation

The device is able to generate two distinct programmable square wave clocks by dividing two different sources with integer dividers:

- 10 MHz
- 16.384 MHz

Please note that the rising edge of the resulting clock is synchronous to the internal PPS, if the frequency is integer.



First Run

First Installation

1. Connect at least one of the possible sources (GPS, E1, PTP, IRIG-B) in the following way:
 - GPS: connect the GPS antenna cable to the proper GPS ANTENNA socket on the rear.
 - EXT: connect a frequency or time reference on the proper connector on the rear.
 - E1: connect an E1 connector on the proper input socket on the back.
 - PTP: connect an ethernet cable to the ethernet port on the back (network should be IEEE 1588 compliant for best performance)
 - IRIG-B: connect a coax or optical connector on the proper sockets on the back (and select the proper input in the IRIG-B Mux selection)
2. Connect the SB-V01 to the power grid.

Checkup

After power on it is possible to connect with the device via WEB by using a common browser at the address `http://<board_ip>`

The default credentials are:

administrator (read and write)	→	admin / admin
guest (read only)	→	guest / guest

From here, it's possible to check:

- Presence of the GPS antenna
In the *GPS* tab of the *Main Panel* the *Antenna* led should be green and, after a few minutes from the boot, the *PPS Status* led should become green, too.
- Presence of the E1 signal
In the *E1* tab of the *Main Panel* the *Signal* and *Framing* leds should be green.
- Presence of the PTP signal
In the *PTP* tab of the *Main Panel* the *Enabled* led should be green and *Status* should display *Slave*.
- Presence of the IRIG-B signal
In the *IRIG-B* tab of the *Main Panel* the *Present* led should be green and *Date* should display a valid date.

Automatic switchover

In order to enable the automatic switchover is better to first check a few settings:

- **Switchover policies**
It is possible to set different policies for the switch.
These policies can be set from the front panel (*Board Settings* → *Policy*), from SNMP (*policy*) or from WEB in the *Board Configuration* page.
- **Switchover treshold**
It is possible to set a treshold to wait before switching to another source.
These policies can be set from the front panel (*Board Settings* → *Switchover*), from SNMP (*switchover*) or from WEB in the *Board Configuration* page.
- **Disciplining mode**
It is possible to specify if the disciplining from the external frequency or from E1 has to be done in frequency or phase.
- **Automatic switchover**
To finally enable the automatic switchover is possible to operate from the front panel (*Board Settings* → *Manual/Auto*), from SNMP (*switchMode*) or from WEB in the *Board Configuratio* page.

Appendix A: Quality Factor

General Review

This appendix is intended to illustrate the meaning and motivation of the introduction of the Quality Factor within the Digital Instruments equipments.

Although the installation of a GPS device is relatively easy, it can hide certain issues that in some cases it can affect the proper functioning.

It is therefore expected to monitoring certain operating parameters so as to make immediate validation of a Circuit or finding the source of any problems.

GPS antenna positioning

GPS antenna should be positioned on a tower or on a roof with a good view of the GPS satellite constellation.

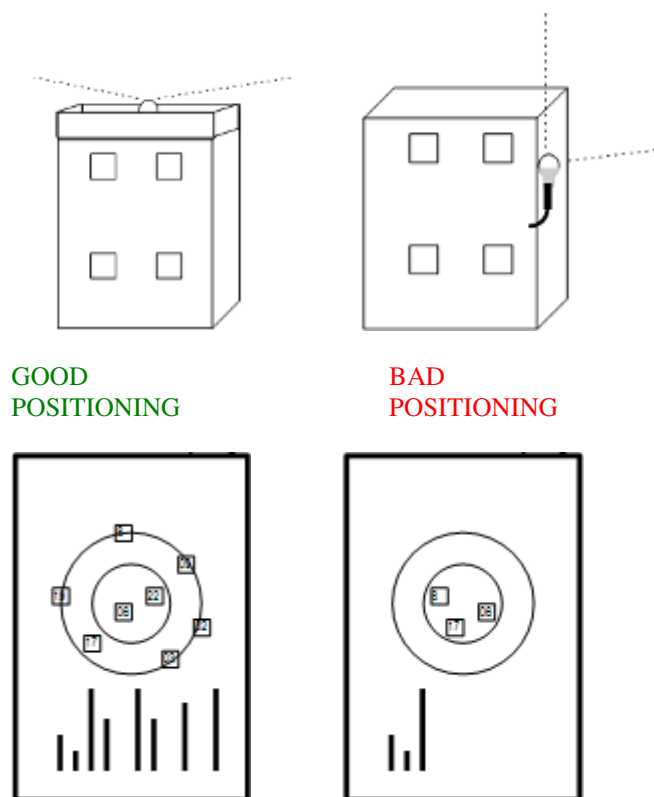

If not, the algorithm of regulation may not behave optimally and *short term stability* of the PPS and 10 MHz references it could be invalidated.

It's possible to evaluate the goodness of the positioning of the antenna in some ways:

1. checking the **power of received signal** from each satellite from the *Polar Plot*
2. checking and verifying that the **Quality Factor** is acceptable (typically > 25)
3. checking that the PPS generated by the radio (**PPS Status**) is valid (green LED)

Se così non fosse l'algoritmo di disciplinamento potrebbe non comportarsi in maniera ottimale e la *short term stability* dei riferimenti PPS e 10 MHz ne potrebbe venire inficiata.

It's possible get an idea of potential obstacles that limit the visibility of the GPS constellation to the radio observing the polar graph of satellites after a few hours of persistence.



Quality Factor

Quality Factor is the operating parameter that indicates the quality of the GPS signal received by the antenna. It is considered an acceptable value if > 25 . If the Q.F. is lower, it is possible that there are problems with the GPS signal reception and this involves a greater number of holdover and therefore a less precise synchronization.

The value of the Quality Factor is shown in *GPS* tab of *Main Panel* Page.

PPS Status: ■

PPS Sync: ■

Antenna: ■

Position: ■

Quality: ■ 28

Statistics

The device stores some useful statistical informations to evaluate the proper functioning over time:

- Holdover Num** shows the number of times that the GPS radio has entered into holdover mode in response to a problem (under optimal conditions should be low)
- Holdover Max** shows the duration of the longer hold-over (under optimal conditions should be low)
- Quality Min** indicates the smallest GPS antenna quality factor recorded (under optimal conditions should be high)
- PPS Dist Max** indicates the maximum distance affected by the PPS generated by the GPS radio (under optimal conditions should be low)
- Pos Alarm Num** indicates the number of times that there was a wrong geo-positioning under optimal conditions should be low)



It's a good idea to reset the stats before a capture session, because some values may be spurious in the first phase of synchronization or acquisition of satellites by the GPS radio.

Automatic Site Survey



In certain situations it may be convenient activate the *Positioning Mode* of GPS radio in *Automatic Site Survey*. In this mode the radio privileges the accuracy of temporal information at the expense of that position (as long as the antenna is not moved), so as to preserve signal integrity PPS in limited visibility conditions or in the GPS constellation or in presence of potential sources of interference.



If there are problems or abnormalities during the first installation or after moving the unit in a distant geographic location, GPS radio can be resetted by deleting the almanac and positioning information that is saved by the appropriate entry in the GPS menu. Should be also necessary to reset the device in *Automatic Site Survey* mode, since the radio, after completing the survey - which takes about 3 hours - automatically returns to *Position Hold* mode.

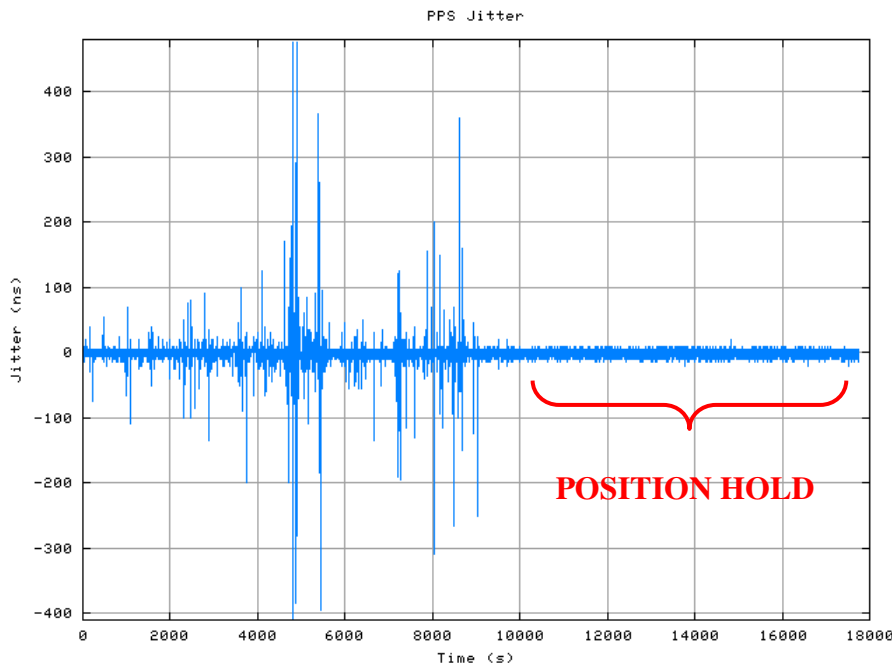

Assistance

For support requests please download the form from the website:

<http://www.digital-instruments.it/ita/assistenza.php>

Compile it in its entirety by specifying as precisely as possible and giving as many details as possible about the type of fault detected.

You can then send the form to **riparazioni@digital-instruments.com**, via fax to **+39.02.66506103**, or enter it directly into the box when sending goods for repair.

You can also contact us at +39.02.66506250 Monday to Friday from 9 to 13 and from 14 to 17 (GMT+1 Time).

Technical Data

GNSS (optional)

Receiver: 1,575.42 MHz – 12 Channels,
Tracking: 12 satellite correlation,
PPS Accuracy: < 50 nsec,
Acquisition time: 4 minutes,
Stability when locked: +/- 1E-12 after 24 hours,
Antenna connector TNC

Interfaces

AC/DC Power option, 70-260 Vac/Vdc
SNMP protocol and integrated Web Server
1 Ethernet shielded RJ45, 10/100 BaseT (also used for management)
1 Time of Day (ToD) output via RS232
1 IRIG-B input (00x/12x) via SMA autosensing
1 IRIG-B input (00x only) via ST
1 RS232 and RS422 serial port via DB9 connector
1 PPS output via SMA connector (optional)
1 10MHz output via SMA connector (optional)
2 IRIG-B output (00x/12x) via SMA (software defined)
2 IRIG-B output (00x only) via ST

IEEE 1588 v2 PTP Output

PTP output client capacity: up to 500 clients
Up to 128 messages per second per client
1-step (2-step clock optional)
PTP Profiles
- C37.238-2011 Precision Time Protocol in Power System Applications
- ITU-T G.8265.1 Frequency Profile (IPV4)
- Default Profile (IEEE 1588 v2)
Best Master Clock Algorithm (BMCA), with Default Profile

IEEE 1588 v2 PTP Input

IPV4
1-step (2-step clock optional)
PTP Profiles
- C37.238-2011 Precision Time Protocol in Power System Applications
- ITU-T G.8265.1 Frequency Profile (IPV4)
- Default Profile (IEEE 1588 v2)

NTP

Protocol: NTPv4
Role: Master Clock Stratum 1 (with GPS) – slave clock Stratum 2

Time and Frequency Accuracy

When locked to GNSS:
Time within 100ns of UTC (ITU-T G.8272 sec. 6 for PRTC)
Frequency: compliant to G.811 frequency accuracy.

Holdover Performance

OCXO: 1E-10 / day (optional)
TCXO: 1PPM

Holdover values are approximated and assume operation at constant temperature, no initial frequency or phase offset, and that the unit has been powered for two weeks and locked to GNSS for three consecutive days.

Synchronous Ethernet

SyncE can be used as a frequency input and can be generated as an output (as Master)
Conforms to relevant sections: ITU-T G.8261, G.8262 and G.8264 ESMC

Network Support

IPV4
ICMP (RFC 792)
HTTP
SNMP
IEEE 1588 v2 PTP
NTP
DSCP

Mechanical

Size:	Height:	112,3	mm
	Width:	71,7	mm
	Depth:	160,0	mm